

Art.-Nr./Item no./N° d'Art. 670518

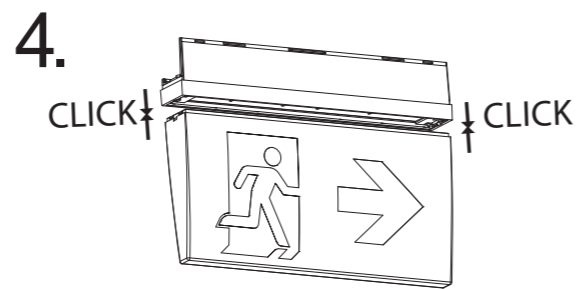

5. a) Decke / ceiling / plafond

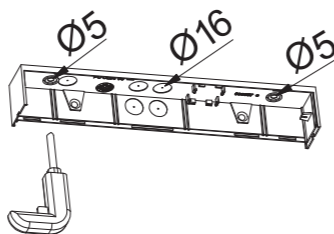

b) Wand / wall / mur

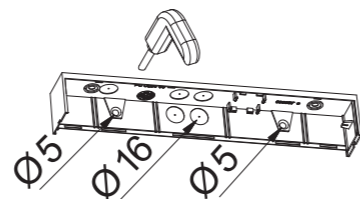

6. a) Decke / ceiling / plafond

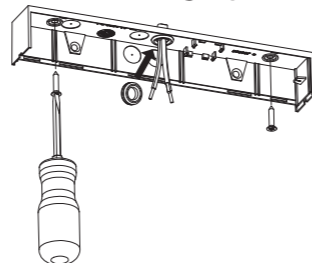

b) Wand / wall / mur

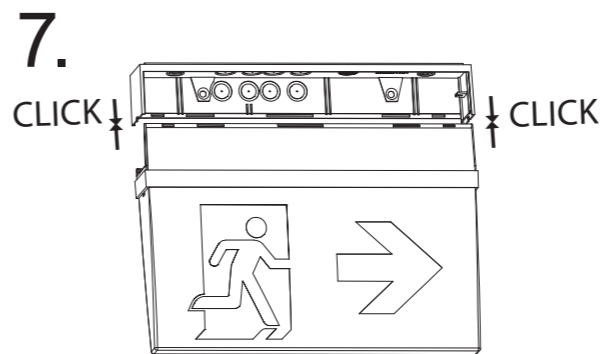
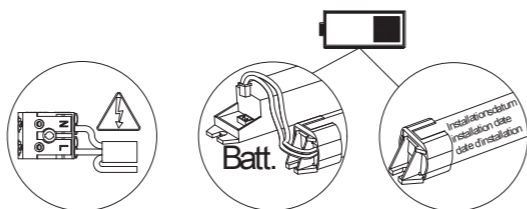
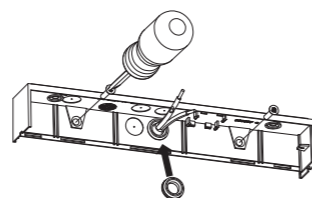

Leuchtmittelwechsel
 Illuminant change
 Agent lumineux variation

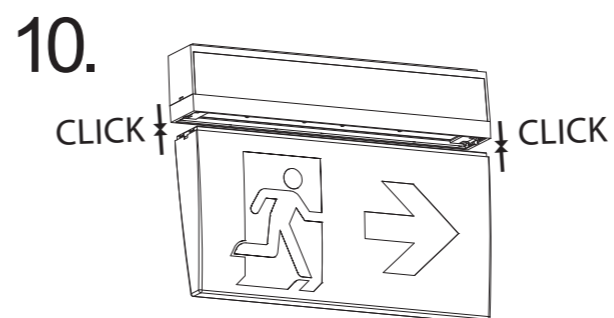
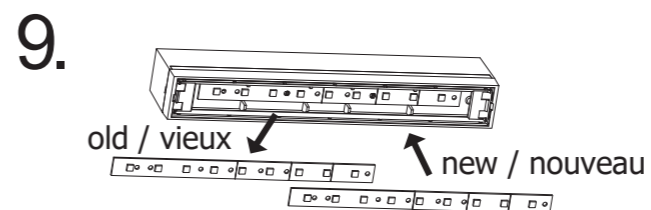
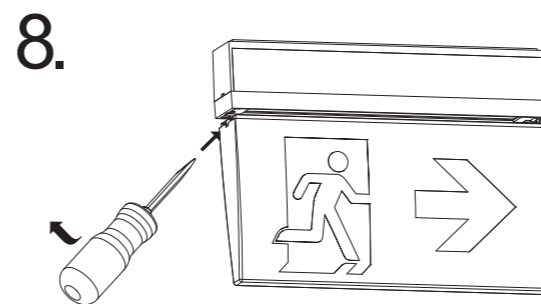

Deckenmontage / ceiling installation / montage au plafond

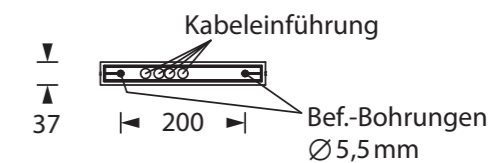
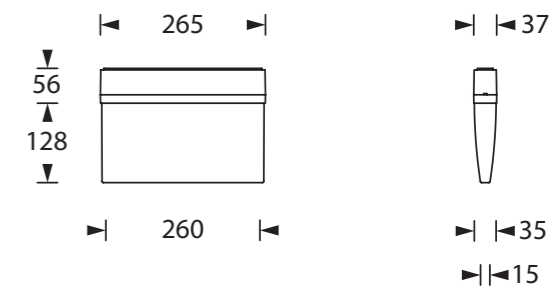

Wandmontage / wall installation / montage au mur

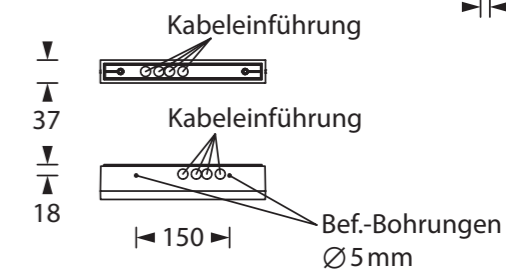
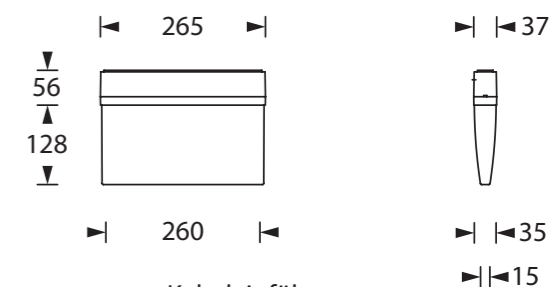

Kabeleinführung
 Cable entry guide
 Introduction de câble
 Bef. Bohrungen
 existing boreholes
 Perçages existants

Rettungszeichenleuchte für Wand- oder Deckenmontage
Diese Anleitung richtet sich ausschließlich an den Elektrofachmann bzw. das ausführende Installationsunternehmen. Bei Installation der Einzelbatterie-Variante zusätzliche Instruktion beachten.

Allgemeine Sicherheitshinweise

Bei der Installation und bei Arbeiten an der Notleuchte sind die notwendigen Sicherheits- und Unfallverhütungsvorschriften, die allgemein anerkannten Regeln der Technik sowie die nachfolgenden Sicherheitshinweise einzuhalten. Insbesondere ist die Leuchte dazu spannungsfrei zu schalten, wobei zu berücksichtigen ist, dass bei Netzlichtbetrieb und Notlichtbetrieb (Netzausfall) unterschiedliche Versorgungsspannungen anstehen können.

Leuchtenausführungen mit Überwachungsbaustein

Bei Leuchtenausführungen mit Überwachungsbaustein zur Leuchten-Einzelüberwachung, sind die Einstellungen der Leuchtenadressen sowie zusätzliche Funktionen entsprechend den Bildern und Angaben auf dem Überwachungsbaustein bzw. in der beiliegenden Einstellungsanleitung vorzunehmen.

Einzelbatterie-Leuchten

Bei Einzelbatterie-Leuchten ist darauf zu achten, dass die Batterie auszutauschen ist, wenn die Leuchte trotz korrekter Ladung der Batterie nicht mehr die erforderliche Brenndauer erreicht.

Entsorgung

Bei der Entsorgung von Leuchten sind die gültigen Vorschriften des ElektroG für Entsorgung und Recycling einzuhalten.

Ersatzteile

Um die Nenndaten der Leuchte sicherzustellen, sind insbesondere bei Leuchtmittel, Elektronik-Komponenten und ggf. Akkumulatoren nur Original-Ersatzteile einzusetzen!

Achtung

Bei Schäden, die durch Nichtbeachtung der Anleitung verursacht werden, erlischt der Garantieanspruch. Für Folgeschäden, die daraus resultieren, übernehmen wir keine Haftung. Diese Bedienungsanleitung ist vor Inbetriebnahme des Produktes genauestens durchzulesen.

Technische Änderungen vorbehalten!

Lampe de signal de secours pour montage au mur ou au plafond
Cette notice s’adresse exclusivement à l’électricien spécialisé ou à l’entreprise en charge de l’installation. Respecter les instructions supplémentaires lors de l’installation de la variante de bloc autonome.

Consignes générales de sécurité
Lors de l’installation et de travaux sur la lampe d’urgence, les consignes nécessaires de sécurité et de prévention des accidents, les règles générales de la technique ainsi que les consignes de sécurité suivantes doivent être respectées. Mettre en particulier la lampe hors tension tout en tenant compte du fait que différentes tensions d’alimentation peuvent être générées lors du fonctionnement de la lumière secteur et de la lumière d’urgence (panne de secteur).

Configurations de lampes avec bloc de surveillance
Sur les configurations de lampes avec bloc de surveillance pour la surveillance individuelle des lampes, effectuer les réglages des adresses de lampes et des fonctions supplémentaires tel illustré sur les figures et les indications du bloc de surveillance et/ou des instructions de réglage fournies.

Lampes à bloc autonome
Veiller, sur les lampes à bloc autonome, à remplacer le bloc si la lampe n’atteint plus la durée d’éclairage requise bien que le bloc soit chargé correctement.

Élimination
Pour l’élimination des lampes, respecter les prescriptions en vigueur de la loi électrique sur l’élimination et le recyclage.

Pièces de rechange
Pour garantir les données nominales de la lampe, utiliser exclusivement les pièces de rechange originales, en particulier pour les sources lumineuses, les composants électriques et, le cas échéant, les accumulateurs !

Attention
En cas de dommages dus au non respect des instructions, toute demande de garantie est annulée. Nous ne saurions être responsable des dommages consécutifs en résultant. Lire l’intégralité de cette notice d’utilisation avant de mettre le produit en service.

Sous réserve de modifications techniques !

Emergency exit luminaire for wall or ceiling mounting
This is a professional manual for certified electricians and professional installation companies only. When installing the self contained version follow the additional instructions.

General safety notices

Relevant safety and accident prevention measures, accepted technology regulations and the following safety notices must be observed when installing or carrying out any work on the safety light. In particular, the lamp must be disconnected from the mains and special care must be taken, as it will still be live from the backup system.

Lamp models with monitoring module
For lamp models with monitoring module for individual lamp monitoring, the configuration of individual lamp addresses and additional functions must be carried out in accordance with the images and data provided on the monitoring module or in the enclosed alignment instructions.

Self contained luminaires

For self contained luminaires the replacement of the battery is needed when the battery no longer meets its rated duration of operation after the corresponding recharge period.

Disposal
Please observe current regulations of ElektroG for the disposal and recycling of lamps.

Spare parts

Only use original parts for the replacement of illuminants, electronic components and accumulators (where applicable) to ensure compliance with nominal data!



Attention



Any damage incurred due to non-compliance with this manual will not be covered by the warranty. We accept no liability for consequential damages incurred due to non-compliance. Make sure to read this manual prior to commissioning the product.

Subject to technical changes without notice!

			
Technische Daten			
<p>Schutzart</p> <i>Protection class</i>	IP 54	Schutzklasse	II / 230V
<i>Indice de protection boîtier</i>		<i>Safety class</i>	2 x 2,5 mm²
		<i>Classe de protection</i>	III / 24V
			2 x 2,5 mm²

	
Abmessungen B x H x T	265 x 184 x 37 mm
<i>Dimensions (W x H x D)</i>	
<i>Dimensions (L x H x P)</i>	

	
Systemleuchten für Zentralversorgung	Einzelbatterieleuchten
Luminaire for CPS	Self contained luminaire
Luminaires de système d'alimentation centrale	Lampe à bloc autonome
24V	230V
	

						
Leuchtmittel						
<i>Illuminants</i>	<table border="1"><tr><td>1W</td></tr><tr><td>LED</td></tr></table>	1W	LED	<table border="1"><tr><td>2W</td></tr><tr><td>LED</td></tr></table>	2W	LED
1W						
LED						
2W						
LED						
<i>Source lumineuse</i>	<table border="1"><tr><td>1W</td></tr><tr><td>LED</td></tr></table>	1W	LED	<table border="1"><tr><td>2W</td></tr><tr><td>LED</td></tr></table>	2W	LED
1W						
LED						
2W						
LED						
Lichtstrom Netz	<table border="1"><tr><td>130lm</td></tr></table>	130lm	<table border="1"><tr><td>260lm</td></tr></table>	260lm		
130lm						
260lm						
<i>Light current net</i>	<table border="1"><tr><td>130lm</td></tr></table>	130lm	<table border="1"><tr><td>260lm</td></tr></table>	260lm		
130lm						
260lm						
<i>Flux lumineux secteur</i>						
Lichtstromverhältnis Not/Netz	<table border="1"><tr><td>1h/3h/8h</td></tr></table>	1h/3h/8h				
1h/3h/8h						
<i>Luminous flux</i>						
<i>Emergency / Mains</i>						
<i>Intensité lumineuse</i>						
<i>Urgence / Secteur</i>						
Netzanschlussleistung	<table border="1"><tr><td>2,1VA</td></tr></table>	2,1VA	<table border="1"><tr><td>3,5VA</td></tr></table>	3,5VA		
2,1VA						
3,5VA						
<i>Power consumption</i>	<table border="1"><tr><td>4,5VA</td></tr></table>	4,5VA	<table border="1"><tr><td>5,5VA</td></tr></table>	5,5VA		
4,5VA						
5,5VA						
<i>Puissance du raccordement</i>						
Batterie-Stromaufnahme	<table border="1"><tr><td>49mA</td></tr></table>	49mA	<table border="1"><tr><td>89mA</td></tr></table>	89mA		
49mA						
89mA						
<i>Battery current input</i>	<table border="1"><tr><td>11mA</td></tr></table>	11mA	<table border="1"><tr><td>14mA</td></tr></table>	14mA		
11mA						
14mA						
<i>Consommation électrique du bloc</i>						
Anschlussspannung	<table border="1"><tr><td>24V 50/60Hz / 0Hz</td></tr></table>	24V 50/60Hz / 0Hz	<table border="1"><tr><td>230V 50/60Hz /220V DC +25/-20%</td></tr></table>	230V 50/60Hz /220V DC +25/-20%		
24V 50/60Hz / 0Hz						
230V 50/60Hz /220V DC +25/-20%						
<i>Voltage supply</i>						
<i>Alimentation</i>						
Nennbetriebsdauer ^{1) 2)}						
<i>Rated duration</i> ^{1) 2)}		<table border="1"><tr><td>1h/3h/8h</td></tr></table>	1h/3h/8h			
1h/3h/8h						
<i>La durée de fonctionnement nominale</i> ^{1) 2)}						
NiMh-Akku						
Battery NiMh 1h/3h/8h		<table border="1"><tr><td>4,8V 0,8Ah</td></tr></table>	4,8V 0,8Ah			
4,8V 0,8Ah						
Temperaturbereich	<table border="1"><tr><td>-10°C – +40°C</td></tr></table>	-10°C – +40°C	<table border="1"><tr><td>-10°C – +40°C</td></tr></table>	-10°C – +40°C		
-10°C – +40°C						
-10°C – +40°C						
<i>Temperature range</i>						
<i>Plage de température</i>						
Bereitschaftsschaltung						
<i>non maintained mode</i>		<table border="1"><tr><td>-0°C – +35°C</td></tr></table>	-0°C – +35°C			
-0°C – +35°C						
<i>mode veille</i>						
Dauerschaltung						
<i>maintained mode</i>		<table border="1"><tr><td>-5°C – +30°C</td></tr></table>	-5°C – +30°C			
-5°C – +30°C						
<i>mode permanent</i>						

¹⁾ Bitte auf dem dafür vorgesehenen Feld des Akkus das Installationsdatum vermerken.
²⁾ Bei Installation der Einzelbatterie-Variante zusätzliche Instruktion beachten.

¹⁾ <i>Note down the installation date on the provided place of the battery.</i>
²⁾ <i>When installing the self contained version follow the additional instructions.</i>

¹⁾ <i>Noter la date d’installation sur le champ de l’accu prévu à cet effet.</i>
²⁾ <i>Respecter les instructions supplémentaires lors de l’installation de la variante de bloc autonome.</i>

	
Caractéristiques techniques	
Anschlussklemmen (mm² für Doppelbelegung)	
<i>Connecting terminals (mm² for double assignment)</i>	
<i>Bornes de raccordement secteur (mm² pour borniers doubles)</i>	